

*simple, available and cost effective™*

DIN 15018

H1 / B3

Max. Tragfähigkeit

Lifting capacity

Force de levage



5.0 t



## Turmversionen • Tower versions • Versions de tours

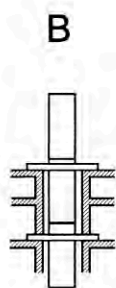
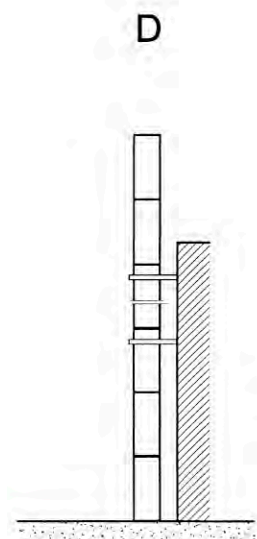
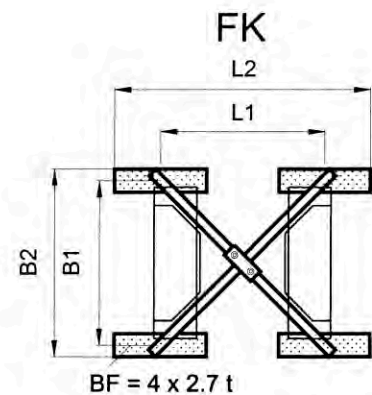
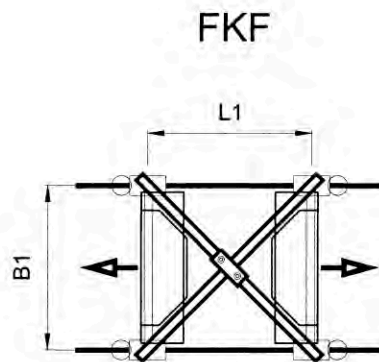
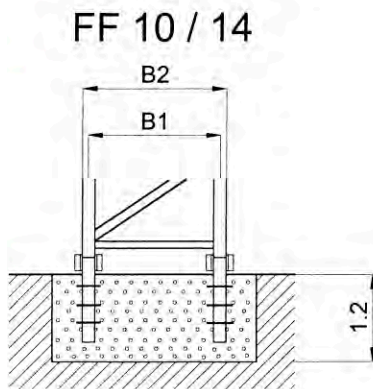
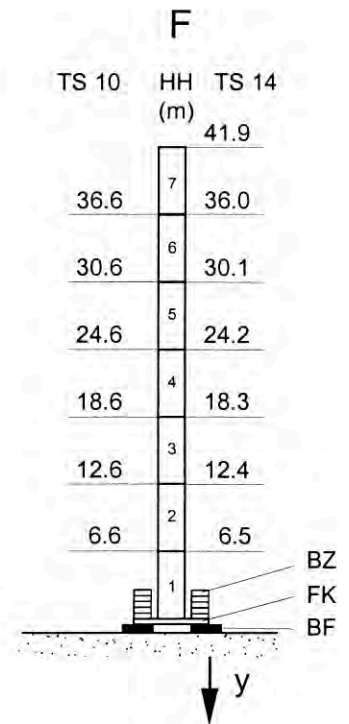
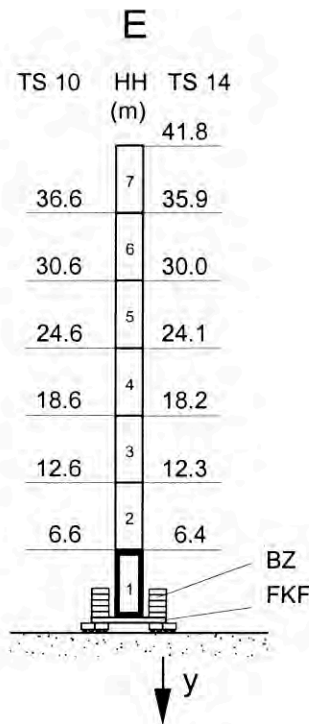
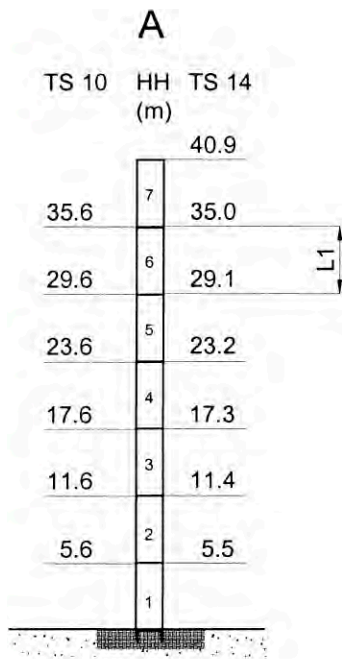

Auf Anfrage  
On request  
Sur demande

	B1	B2	L1	L2	y / ●	y / ■
	m				kN	
FK 310	3.40	4.10	3.40	6.20	437	475
FK 410	4.05	4.75	4.05	6.85	361	392
FK 414	4.05	4.75	4.05	6.85	444	583
FK 514	5.05	5.75	5.05	7.85	370	470
FKF 410	4.00		4.05		335	307
FKF 414	4.00		4.05		473	581
FKF 514	5.00		5.05		393	467
TS 10.4	1.06	1.20	12.00			
TS 10.3	1.06	1.20	6.00			
TSV 10.3	1.06	1.20	6.00			
TS 14.4	1.40	1.54	11.80			
TS 14.3	1.40	1.54	5.90			

● in Betrieb / in operation / en service

■ außer Betrieb / out of operation / sans service

## Ausladung und Tragfähigkeit • Radius and capacity • Portée et charge

Ausleger Jib Flèche	Max. Tragfähigkeit Max. Capacity Charge max.	Ausladung (m) und Tragfähigkeit (t) Radius (m) and capacity (t) Portée (m) et charge (t)																	
		16	18	20	22	24	26	28	30	33	35	38	40	41	42	43	44	45	
<b>L4 45.0</b>	<b>2.5 - 14.2 m</b>	4.36	3.81	3.37	3.02	2.73	2.49	2.29	2.11	1.89	1.76	1.60	1.50	1.46	1.41	1.37	1.34	1.30	
<b>L3 40.0</b>	<b>2.5 - 15.3 m</b>	4.75	4.15	3.68	3.30	2.99	2.73	2.50	2.31	2.07	1.93	1.75	1.65						
<b>L2 35.0</b>	<b>2.5 - 16.4 m</b>	5.00	4.49	3.99	3.58	3.24	2.96	2.72	2.51	2.25	2.10								
<b>L1 30.0</b>	<b>2.5 - 16.9 m</b>	5.00	4.65	4.12	3.70	3.35	3.06	2.81	2.60										



## Ballastierung • Ballast • Lest

**Version F** – mit Zentralballast und Fundamentballast / with Central ballast block and Foundation block / avec Lest de base et Bloc de fondation – **BZ + BF**

<b>HH</b>	(m)	<b>6.7</b>	<b>12.7</b>	<b>18.7</b>	<b>24.7</b>	<b>30.7</b>	<b>36.7</b>	
<b>FK 310</b>	(t)	30.8	30.8	30.8	40.8	50.8	70.8	
<b>HH</b>	(m)	<b>6.6</b>	<b>12.6</b>	<b>18.6</b>	<b>24.6</b>	<b>30.6</b>	<b>36.6</b>	
<b>FK 410</b>	(t)	30.8	30.8	30.8	30.8	40.8	50.8	
<b>HH</b>	(m)	<b>6.5</b>	<b>12.4</b>	<b>18.3</b>	<b>24.2</b>	<b>30.1</b>	<b>36.0</b>	<b>41.9</b>
<b>FK 414</b>	(t)	30.8	30.8	30.8	30.8	40.8	60.8	70.8
<b>HH</b>	(m)	<b>6.7</b>	<b>12.6</b>	<b>18.5</b>	<b>24.4</b>	<b>30.3</b>	<b>36.2</b>	<b>42.1</b>
<b>FK 514</b>	(t)	43.0	43.0	43.0	43.0	43.0	43.0	53.0









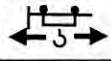

**Version E** – mit Zentralballast / with Central ballast block / avec Lest de base – **BZ**

<b>HH</b>	(m)	<b>6.6</b>	<b>12.6</b>	<b>18.6</b>	<b>24.6</b>	<b>30.6</b>	<b>36.6</b>	
<b>FKF 410</b>	(t)	20.0	20.0	20.0	30.0	40.0	50.0	
<b>HH</b>	(m)	<b>6.4</b>	<b>12.3</b>	<b>18.2</b>	<b>24.1</b>	<b>30.0</b>	<b>35.9</b>	<b>41.8</b>
<b>FKF 414</b>	(t)	20.0	20.0	20.0	30.0	40.0	60.0	70.0
<b>HH</b>	(m)	<b>6.5</b>	<b>12.4</b>	<b>18.3</b>	<b>24.2</b>	<b>30.1</b>	<b>36.0</b>	<b>41.9</b>
<b>FKF 514</b>	(t)	32.2	32.2	32.2	32.2	32.2	32.2	52.2

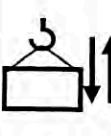
## Gegengewichtsballast • Counterweight • Contrepoids

Ausleger / Jib / Flèche		<b>L1</b>	<b>L2</b>	<b>L3</b>	<b>L4</b>
<b>BG</b>		7.50	8.15	8.90	10.45
	(t)	3 x 2.50	2 x 2.50 1 x 3.15	1 x 2.50 2 x 3.15	3 x 3.15

## Geschwindigkeiten • Speeds • Vitesses

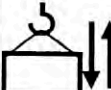
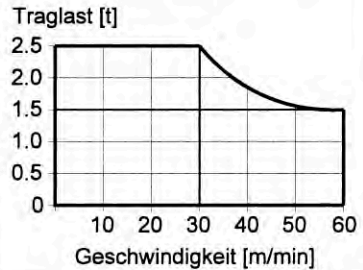
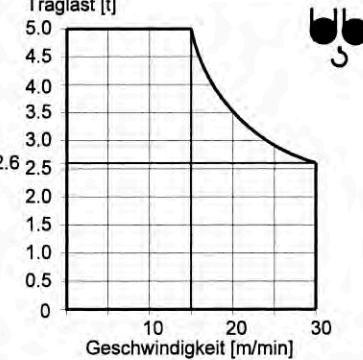
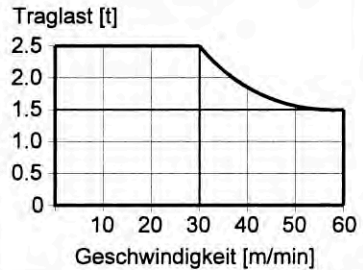
PU S 4-50/2		$v =$ 22 / 45 m / min.	4.0 kW	400 V 50 Hz 3 Ph		
SR 5-90/3		$v = 0 \rightarrow$ 25 m / min.	2 x 5.0 kW			
K SRA 75/4		$v = 0 \rightarrow$ 0.75 min <sup>-1</sup>	1 x 75 Nm			
 <b>HK max. = 85 m</b> <b>2 - Lagen / 2 - layers / 2 - couches</b>						
Type PU 15-25/3 15.0 kW		 $\rightarrow$ 52 m / min	1 500 kg		<b>Motorenleistung ges.</b> Total motor output Puissance moteur (ohne/without/sans SR 5-90/3) ~ 23 kW <hr/> <b>Anschlussleistung</b> Connected power Puissance installée <b>100 kVA</b>	
		 $\rightarrow$ 26 m / min	2 500 kg			$\rightarrow$ 13 m / min
		 $\rightarrow$ 6 m / min				$\rightarrow$ 3 m / min
 <b>HK max. = 85 m</b> <b>2 - Lagen / 2 - layers / 2 - couches</b>						
Type FU 17-25/5 15.0 kW					<b>Motorenleistung ges.</b> Total motor output Puissance moteur (ohne/without/sans SR 5-90/3) ~ 23 kW <hr/> <b>Anschlussleistung</b> Connected power Puissance installée <b>50 kVA</b>	
						

Unsere Vertretung:  
Our representative:  
Notre représentant: